

MOTOR		
Hersteller / Modell	Cummins QSL9	
Typ	Turboaufgeladener 4-Takt-Dieselmotor mit Ladeluftkühlung	
Nennleistung am Schwungrad	SAE J1995 (brutto)	316 PS (236 kW) bei 1650 U/min
	SAE J1349 (netto)	300 PS (224 kW) bei 1650 U/min
	DIN 6271/1 (brutto)	320 PS (236 kW) bei 1650 U/min
	DIN 6271/1 (netto)	304 PS (224 kW) bei 1650 U/min
Höchst Drehmoment	145.3 kgf·m (1.050 lbf·ft) bei 1500 U/min	
Bohrung × Hub	114 × 145 mm (4.49" × 5.69")	
Hubraum	8900 cc (543 Kubikzoll)	
Batterien	2 × 12 V × 160 Ah	
Anlasser	Denso 24 V - 7,8 kW	
Generator	Denso 24 V - 95 A	

HYDRAULIKSYSTEM	
HAUPTPUMPE	
Typ	Variable Kolbenpumpen
Maximaler Durchfluss	2 × 288,8 l/min (76,3 U.S. gpm / 63,5 U.K. gpm)
Hilfspumpe für Vorsteuerkreis	Zahnradpumpe

Quer erfassendes und kraftstoffsparendes Pumpensystem

HYDRAULIKMOTOREN	
Fahren	Axialkolbenmotor mit zwei Geschwindigkeiten mit Bremsventil und Parkbremse
Schwenken	Axialkolbenmotor mit automatischer Bremse

ÜBERDRUCKVENTILEINSTELLUNG	
Anbaugerätekreise	330 kgf/cm ² (4690 psi)
Fahren	360 kgf/cm ² (5120 psi)
Leistungsstufe (Ausleger, Löffelstiel, Löffel)	360 kgf/cm ² (5120 psi)
Schwenkkreis	290 kgf/cm ² (4120 psi)
Vorsteuerkreis	40 kgf/cm ² (569 psi)
Serviceventil	Installiert

HYDRAULIKZYLINDER	
Zylinder: Bohrung × Hub	Ausleger: Ø 160 × 1500 mm
	Löffelstiel: Ø 170 × 1760 mm
	Tiefelöffel: Ø 150 × 1295 mm

ANTRIEBE UND BREMSSEN	
Antriebsart	Vollhydrostatisch
Antriebsmotor	Axialkolbenmotor, mit Bremse integriert
Untersetzung	Planetenuntersetzungsgetriebe
Max. Zugkraft	30500 kgf (67,240 lbf)
Max. Fahrgeschwindigkeit (Schnell-/Langsamgang)	5,0 km/h (3,1 mph) / 3,1 km/h (1,92 mph)
Steigfähigkeit	35° (70%)
Handbremse	Mehrscheibenausführung, nass

STEUERUNG	
Vorsteuerdruckunterstützte Joysticks und Pedale mit abnehmbarem Hebel für nahezu kraft- und ermüdungsfreie Bedienung.	
Vorsteuerung	Zwei Joysticks mit einem Sicherheitshebel (links): Schwenken und Löffelstiel (rechts): Ausleger und Tiefelöffel (ISO)
Fahren und Lenken	Zwei Hebel mit Pedalen
Motordrossel	Elektrisch, als Drehregler ausgeführt

SCHWENKWERK	
Schwenkmotor	Axialkolbenmotor mit festem Schluckvolumen
Schwenkuntersetzung	Planetenraduntersetzung
Drehkransschmierung	Fettbad
Schwenkbremse	Mehrscheibenausführung, nass
Schwenkgeschwindigkeit	9,5 U/min

SERVICE-FÜLLMENGEN			
Nachfüllmenge	Liter	US gal	UK gal
Kraftstofftank	550	145	120
Motorkühlmittel	55	14,5	12,1
Motoröl	30	7,9	6,6
Schwenkeinrichtung	8	2,1	1,8
Endantrieb (je)	5,5	1,5	1,2
Hydrauliksystem (einschl. Behälter)	414	109	90
Hydraulikölbehälter	210	55	45
DEF/AdBlue®	42,5	11,2	9,3

UNTERWAGEN	
Der X-Mittelrahmen ist eine vollverschweißte Konstruktion mit verstärkten Kastenrahmen für das Laufwerk. Der Unterwagen ist mit geschmierten Rollen, Leiträdern, Kettenspannern mit stoßdämpfenden Federn und Antriebsrädern sowie Raupenkettensystemen mit 2- oder 3-Steg-Bodenplatten ausgerüstet.	
Mittelrahmen	X-Rahmen
Unterwagen	Fünfeckiges Kastenprofil
Kettenplatten pro Seite	51 je
Stützrollen pro Seite	2 je
Laufrollen pro Seite	9 je
Kettenführungen pro Seite	2 je

BETRIEBSGEWICHT (CIRCA)	
Betriebsgewicht, einschliesslich 6500 mm (21' 4") Ausleger; 3200 mm (10' 6") Löffelstiel; 1,62 m ³ (2.12 yd ³) Löffel gehäuft nach SAE, Schmiermittel, Kühlmittel, vollem Kraftstofftank, vollem Hydraulikölbehälter und aller Standardausrüstung.	

BETRIEBSGEWICHT					
Platten	Typ	Breite mm (in)	Betriebsgewicht		Bodendruck kgf/cm ² (psi)
			kg (lb)		
Dreisteg	600 (24")	HX380 L	38920 (85,800)	0,70 (9,95)	
			38820 (85,580)	0,70 (9,95)	
	700 (28")	HX380 L	39370 (86,800)	0,61 (8,67)	
			39595 (87,290)	0,57 (8,11)	
			39820 (87,790)	0,54 (7,68)	
Doppelsteg	700 (28")	HX380 L	40270 (88,780)	0,48 (6,83)	
			39165 (86,340)	0,70 (9,95)	
Hohe Beanspruchung Steg	600 (24")	HX380 HD	29665 (87,450)	0,61 (8,67)	
			39280 (86,600)	0,71 (10,10)	
	700 (28")	HX380 HD	39775 (87,690)	0,61 (8,67)	

AUSWAHLHILFE BAGGERLÖFFEL UND SCHACHTKRAFT

HX380 L

LÖFFEL

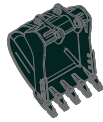
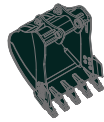

gehäuft nach SAE
m³ (yd³)

1,46 (1.91)
1,62 (2.12)
1,90 (2.49)
2,10 (2.75)
2,32 (3.03)

◆ 1,46 (1.91)
◆ 1,62 (2.12)
◆ 1,90 (2.49)
◆ 2,10 (2.75)

◆ 1,46 (1.91)
◆ 1,62 (2.12)
◆ 1,90 (2.49)

Inhalt m ³ (yd ³)		Breite mm (in)	Gewicht kg (lb)	Empfehlung mm (ft.in)			
gehäuft nach SAE	gehäuft nach CECE			6150 (20' 2") Ausleger	6500 (21' 4") Ausleger		
				2500 (8' 2") Löffelstiel	2500 (8' 2") Löffelstiel	3200 (10' 6") Löffelstiel	3900 (12' 10") Löffelstiel
1,46 (1.91)	1,28 (1.67)	1370 (54")	1400 (3,090)	●	●	●	⊙
1,62 (2.12)	1,42 (1.86)	1480 (58")	1500 (3,310)	●	●	●	⊙
1,90 (2.49)	1,65 (2.16)	1665 (66")	1610 (2,450)	⊙	⊙	○	○
2,10 (2.75)	1,84 (2.41)	1800 (71")	1690 (3,730)	⊙	○	○	○
2,32 (3.03)	2,02 (2.64)	1950 (77")	1800 (3,970)	○	○	○	-
◆ 1,46 (1.91)	1,28 (1.67)	1370 (54")	1560 (3,440)	●	●	●	⊙
◆ 1,62 (2.12)	1,42 (1.86)	1480 (58")	1660 (3,660)	●	●	⊙	○
◆ 1,90 (2.49)	1,65 (2.16)	1665 (66")	1790 (3,950)	⊙	⊙	○	○
◆ 2,10 (2.75)	1,84 (2.41)	1800 (71")	1880 (4,140)	⊙	○	○	-
◆ 1,46 (1.91)	1,28 (1.67)	1370 (54")	1750 (3,860)	●	●	⊙	⊙
◆ 1,62 (2.12)	1,42 (1.86)	1480 (58")	1850 (4,080)	●	●	⊙	○
◆ 1,90 (2.49)	1,65 (2.16)	1665 (66")	1990 (4,390)	⊙	○	○	○

◆ Tieflöffel für hohe Beanspruchung
◆ Felslöffel für hohe Beanspruchung

● : Für Material mit einer Dichte von maximal 2000 kg / m³ (3370 lb/ yd³)
⊙ : Für Material mit einer Dichte von maximal 1600 kg / m³ (2700 lb/ yd³)
○ : Für Material mit einer Dichte von maximal 1100 kg / m³ (1850 lb/ yd³)

ANBAUGERÄT

Ausleger und Löffelstiel sind als verschweißtes, spannungsarmes Kastenprofil ausgeführt.
Erhältlich: Ausleger in 6,15 m (20' 2") and 6,5 m (21' 4") und Löffelstiel in 2,5 m (8' 2"); 3,2 m (10' 6") und 3,9 m (12' 10").

SCHACHTKRAFT

Ausleger	Länge	mm (ft.in)	6150 (20' 2")		6500 (21' 4")		Anmer- kungen:
	Gewicht	kg (lb)	3750 (8,270)	3850 (8,490)			
Löffelstiel	Länge	mm (ft.in)	2500 (8' 2")	2500 (8' 2")	3200 (10' 6")	3900 (12' 10")	[]: Leistungs- stufe
	Gewicht	kg (lb)	1960 (4,320)	1960 (4,320)	2120 (4,670)	2190 (4,830)	
Tieflöffel Losbrech- kraft	SAE	kN	201,0 [219,3]	201,0 [219,3]	201,0 [219,3]	201,0 [219,3]	
		kgf	20500 [22360]	20500 [22360]	20500 [22360]	20500 [22360]	
		lbf	45190 [49300]	45190 [49300]	45190 [49300]	45190 [49300]	
	ISO	kN	228,5 [249,3]	228,5 [249,3]	228,5 [249,3]	228,5 [249,3]	
		kgf	23300 [25420]	23300 [25420]	23300 [25420]	23300 [25420]	
		lbf	51370 [56040]	51370 [56040]	51370 [56040]	51370 [56040]	
Tieflöffelstiel Reißkraft	SAE	kN	192,2 [209,7]	192,2 [209,7]	160,8 [175,4]	160,8 [175,4]	
		kgf	19600 [21380]	19600 [21380]	16400 [17890]	16400 [17890]	
		lbf	43210 [47130]	43210 [47130]	36160 [39440]	36160 [39440]	
	ISO	kN	200,1 [218,2]	200,1 [218,2]	165,7 [180,8]	165,7 [180,8]	
		kgf	20400 [22250]	20400 [22250]	16900 [18440]	16900 [18440]	
		lbf	44970 [49050]	44970 [49050]	37260 [40650]	37260 [40650]	

Hinweis : Auslegergewicht inklusive Stielzylinder, Verrohrung und Bolzen.
Stielgewicht inklusive Löffelzylinder, Verbindungsstangen und Bolzen.

MASSE UND ARBEITSBEREICH

HX380 L

ABMESSUNGEN HX380 L / HX380 NL

Ausleger in 6,15 m (20' 2") und 6,5 m (21' 4") und Löffelstiel in 2,5 m (8' 2"); 3,2 m (10' 6") und 3,9 m (12' 10")

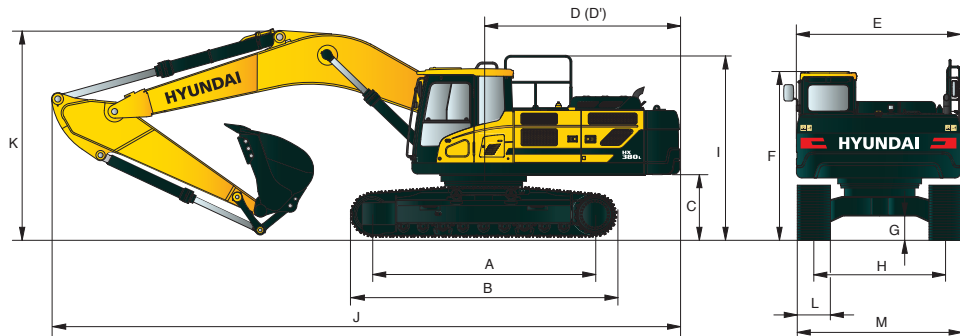

Einheit : mm (ft-in)

A	Aufstandslänge	4340 (14' 3")
B	Gesamtlänge der Raupe	5280 (17' 4")
C	Bodenfreiheit des Heckgegengewichts	1295 (4' 2")
D	Heckschwenkradius	3640 (11' 9")
D'	Hecklänge	3555 (11' 7")
E	Gesamtbreite des Oberwagens	2980 (9' 9")
F	Gesamthöhe der Kabine	3240 (10' 6")
G	Mindest-Bodenfreiheit	550 (1' 10")
H	Spurweite	HX380 L 2740 (9' 0") HX380 NL 2390 (7' 10")
I	Gesamthöhe des Schutzgeländers	3445 (10' 3")

Auslegerlänge	6150 (20' 2")	6500 (21' 4")			
Löffelstiellänge	2500 (8' 2")	2500 (8' 2")	3200 (10' 6")	3900 (12' 10")	
J Gesamtlänge	11100 (36' 5")	11450 (37' 7")	11400 (30' 5")	11400 (37' 5")	
K Gesamthöhe des Auslegers	3830 (12' 7")	3740 (12' 3")	3630 (11' 11")	3740 (12' 3")	
L Breite der Bodenplatten	600 (24")	700 (28")	750 (30")	800 (32")	900 (36")
M Gesamtbreite	HX380 L 3340 (10' 11")	3440 (11' 3")	3490 (11' 5")	3540 (11' 7")	3640 (11' 11")
	HX380 NL 2990 (9' 10")				

ARBEITSBEREICH HX380 L / HX380 NL

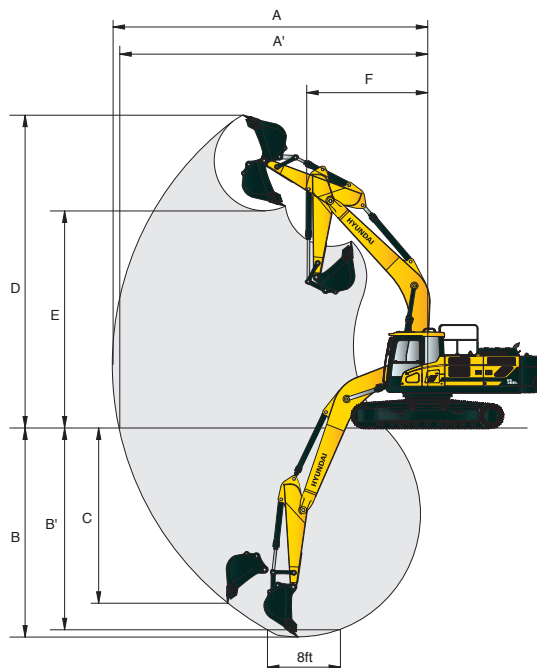











Einheit : mm (ft-in)

Auslegerlänge	6150 (20' 2")	6500 (21' 4")		
Löffelstiellänge	2500 (8' 2")	2500 (8' 2")	3200 (10' 6")	3900 (12' 10")
A Max. Schachtweite	10300 (33' 10")	10650 (34' 11")	11160 (36' 7")	11820 (38' 9")
A' Max. Schachtweite am Boden	10060 (33' 0")	10410 (34' 2")	10930 (35' 10")	11620 (38' 1")
B Max. Schachttiefe	6560 (21' 6")	6820 (22' 5")	7520 (24' 8")	8220 (27' 0")
B' Max. Schachttiefe (auf ca. 2,40 m)	6380 (20' 11")	6640 (21' 5")	7360 (24' 2")	8080 (26' 6")
C Max. vertikale Abstechtiefe	4780 (15' 8")	5030 (16' 6")	5480 (18' 0")	6300 (20' 8")
D Max. Einstechhöhe	10000 (32' 10")	10330 (33' 11")	10270 (33' 8")	10610 (34' 10")
E Max. Ladehöhe	6870 (22' 6")	7190 (23' 7")	7190 (23' 7")	7500 (24' 7")
F Min. Frontschwenkradius	4310 (14' 2")	4490 (14' 9")	4490 (14' 9")	4350 (14' 3")











 Lastradius Frontauslage  Lastradius Seitenauslage bzw. 360 Grad

HX380 L













6,15 m (20' 2") Ausleger; 2,5 m (8' 2") Löffelstiel; 1,62 m³ Löffel (nach SAE gehäuft); 600 mm (24") 3-Steg-Bodenplatten

Lasthöhe m (ft)	Lastradius								Max. Reichweite		Reichweite m (ft)	
	3.0 m (10 ft)		4.5 m (15 ft)		6.0 m (20 ft)		7.5 m (25 ft)		Volumen			
												
7.5 m (25 ft)	kg									*7140	6330	7.60
	lb									*15740	13960	(24.9)
6.0 m (20 ft)	kg					*8000	*8000	*7650	6450	*7220	4940	8.51
	lb					*17640	*17640	*16870	14220	*15920	10890	(27.9)
4.5 m (15 ft)	kg			*11730	*11730	*9300	9270	*8160	6220	*7410	4230	9.05
	lb			*25860	*25860	*20500	20440	*17990	13710	*16340	9330	(29.7)
3.0 m (10 ft)	kg			*15260	13520	*10940	8580	*8970	5890	7040	3880	9.29
	lb			*33640	29810	*24120	18920	*19780	12990	15520	8550	(30.5)
1.5 m (5 ft)	kg			*17820	12430	*12410	7990	*9770	5580	6960	3790	9.26
	lb			*39290	27400	*27360	17610	*21540	12300	15340	8360	(30.4)
Boden-niveau	kg			*18720	12010	*13290	7630	9790	5360	7310	3980	8.95
	lb			*41270	26480	*29300	16820	21580	11820	16120	8770	(29.4)
-1.5 m (-5 ft)	kg	*20170	*20170	*18370	11960	*13390	7510	9720	5300	8250	4520	8.33
	lb	*44470	*44470	*40500	26370	*29520	16560	21430	11680	18190	9960	(27.3)
-3.0 m (-10 ft)	kg	*23770	*23770	*16880	12180	*12440	7620			*8790	5770	7.31
	lb	*52400	*52400	*37210	26850	*27430	16800			*19380	12720	(24.0)
-4.5 m (-15 ft)	kg	*18720	*18720	*13510	12730					*8150	*8150	5.64
	lb	*41270	*41270	*29780	28060					*17970	*17970	(18.5)
-9.0 m (-30 ft)	kg									*5210	*5210	8.69
	lb									*11490	*11490	(28.5)

6,5 m (21' 4") Ausleger; 2,5 m (8' 2") Löffelstiel; 1,62 m³ Löffel (nach SAE gehäuft); 600 mm (24") 3-Steg-Bodenplatten

Lasthöhe m (ft)	Lastradius								Max. Reichweite		Reichweite m (ft)	
	3.0 m (10 ft)		4.5 m (15 ft)		6.0 m (20 ft)		7.5 m (25 ft)		Volumen			
												
9.0 m (30 ft)	kg									*6870	*6870	6.69
	lb									*15150	*15150	(21.9)
7.5 m (25 ft)	kg									*6750	5630	8.04
	lb									*14880	12410	(26.4)
6.0 m (20 ft)	kg					*7870	*7870	*7290	6420	*6820	4450	8.90
	lb					*17350	*17350	*16070	14150	*15040	9810	(29.2)
4.5 m (15 ft)	kg			*12110	*12110	*9260	9080	*7920	6130	6940	3830	9.41
	lb			*26700	*26700	*20410	20020	*17460	13510	15300	8440	(30.9)
3.0 m (10 ft)	kg			*15660	12950	*10910	8340	*8770	5760	6500	3520	9.64
	lb			*34520	28550	*24050	18390	*19330	12700	14330	7760	(31.6)
1.5 m (5 ft)	kg			*17900	11950	*12310	7740	*9570	5430	6430	3440	9.61
	lb			*39460	26350	*27140	17060	*21100	11970	14180	7580	(31.5)
Boden-niveau	kg			*18450	11650	*13100	7390	9620	5200	6720	3590	9.32
	lb			*40680	25680	*28880	16290	21210	11460	14820	7910	(30.6)
-1.5 m (-5 ft)	kg	*17120	*17120	*17970	11670	*13160	7290	9530	5130	7520	4050	8.73
	lb	*37740	*37740	*39620	25730	*29010	16070	21010	11310	16580	8930	(28.6)
-3.0 m (-10 ft)	kg	*22880	*22880	*16570	11900	*12350	7390			*8190	5070	7.77
	lb	*50440	*50440	*36530	26230	*27230	16290			*18060	11180	(25.5)
-4.5 m (-15 ft)	kg	*18610	*18610	*13720	12400					*7770	7640	6.25
	lb	*41030	*41030	*30250	27340					*17130	16840	(20.5)

6,5 m (21' 4") Ausleger; 3,2 m (10' 6") Löffelstiel; 1,62 m³ Löffel (nach SAE gehäuft); 600 mm (24") 3-Steg-Bodenplatten















Lasthöhe m (ft)	Lastradius								Max. Reichweite		Reichweite m (ft)					
	1.5 m (5 ft)		3.0 m (10 ft)		4.5 m (15 ft)		6.0 m (20 ft)		7.5 m (25 ft)			9.0 m (30 ft)				
																
9.0 m (30 ft)	kg											*5840	*5840	7.44		
	lb											*12870	*12870	(24.4)		
7.5 m (25 ft)	kg							*6080	*6080			*5870	4950	8.66		
	lb							*13400	*13400			*12940	10910	(28.4)		
6.0 m (20 ft)	kg							*6370	*6370			*6010	3980	9.46		
	lb							*14040	*14040			*13250	8770	(31.0)		
4.5 m (15 ft)	kg							*8110	*8110	*7090	6260	*6320	4350	9.94		
	lb							*17880	*17880	*15630	13800	*13930	9590	*13710	7580	(32.6)
3.0 m (10 ft)	kg					*13710	13600	*9860	8550	*8030	5840	*7050	4140	5920	3150	10.16
	lb					*30230	29980	*21740	18850	*17700	12870	*15540	9130	13050	6940	(33.3)
1.5 m (5 ft)	kg					*16620	12240	*11480	7840	*8970	5440	7250	3920	5830	3050	10.13
	lb					*36640	26980	*25310	17280	*19780	11990	15980	8640	12850	6720	(33.2)
Boden-niveau	kg			*11670	*11670	*18010	11600	*12600	7360	9570	5150	7060	3760	6030	3150	9.85
	lb			*25730	*25730	*39710	25570	*27780	16230	21100	11350	15560	8290	13290	6940	(32.3)
-1.5 m (-5 ft)	kg	*13240	*13240	*16670	*16670	*18180	11420	*13040	7140	9390	4990			6630	3490	9.30
	lb	*29190	*29190	*36750	*36750	*40080	25180	*28750	15740	20700	11000			14620	7690	(30.5)
-3.0 m (-10 ft)	kg	*17860	*17860	*22550	*22550	*17340	11520	*12710	7140	9400	5000			*7870	4240	8.41
	lb	*39370	*39370	*49710	*49710	*38230	25400	*28020	15740	20720	11020			*17350	9350	(27.6)
-4.5 m (-15 ft)	kg			*21770	*21770	*15310	11880	*11270	7370					*8060	5950	7.05
	lb			*47990	*47990	*33750	26190	*24850	16250					*17770	13120	(23.1)
-6.0 m (-20 ft)	kg					*11030	*11030									
	lb					*24320	*24320									

- Die Hublast richtet sich nach der Definition in SAE J1097 und ISO 10567.
- Die Hublast der Serie ROBEX darf auf festem, ebenem Untergrund maximal 75 % der Kipplast der Maschine bzw. 87 % der gesamten hydraulischen Hubkraft betragen.
- Der Lasthaken befindet sich an der Rückseite des Tieflöffels.
- (*) gibt die Lastbegrenzung durch die hydraulische Hubkraft an.

 Lastradius Frontauslage  Lastradius Seitenauslage bzw. 360 Grad











HX380 L

6,5 m (21' 4") Ausleger; 3,9 m (12' 10") Löffelstiel; 1,62 m³ Löffel (nach SAE gehäuft); 600 mm (24") 3-Steg-Bodenplatten











Lasthöhe m (ft)	Lastradius												Max. Reichweite			
	1.5 m (5 ft)		3.0 m (10 ft)		4.5 m (15 ft)		6.0 m (20 ft)		7.5 m (25 ft)		9.0 m (30 ft)		Volumen	Reichweite		
															m (ft)	
9.0 m (30 ft)	kg												*5120	*5120	8.35	
	lb												*11290	*11290	(27.4)	
7.5 m (25 ft)	kg												*5210	4190	9.44	
	lb												*11490	9240	(31.0)	
6.0 m (20 ft)	kg												*4810	4640	10.17	
	lb												*10600	10230	(33.4)	
4.5 m (15 ft)	kg								*6290	*6290	*5900	4470	*5580	2990	10.62	
	lb								*13870	*13870	*13010	9850	*12300	6590	(34.8)	
3.0 m (10 ft)	kg		*20290	*20290	*11890	*11890	*8840	*8840	*7320	6010	*6480	4220	5280	2750	10.82	
	lb		*44730	*44730	*26210	*26210	*19490	*19490	*16140	13250	*14290	9300	11640	6060	(35.5)	
1.5 m (5 ft)	kg		*10690	*10690	*15290	12810	*10670	8100	*8390	5570	*7100	3970	5200	2660	10.79	
	lb		*23570	*23570	*33710	28240	*23520	17860	*18500	12280	*15650	8750	11460	5860	(35.4)	
Boden-niveau	kg		*12110	*12110	*17390	11870	*12080	7510	*92290	5210	7070	3760	5350	2730	10.53	
	lb		*26700	*26700	*38340	26170	*26630	16560	*20480	11490	15590	8290	11790	6020	(34.5)	
-1.5 m (-5 ft)	kg	*11600	*11600	*15390	*15390	*18190	11480	*12860	7180	9390	4980	6930	3630	5790	2980	10.02
	lb	*25570	*25570	*33930	*33930	*40100	25310	*28350	15830	20700	10980	15280	8000	12760	6570	(32.9)
-3.0 m (-10 ft)	kg	*15300	*15300	*19710	*19710	*17910	11430	*12930	7070	9300	4900			6710	3520	9.21
	lb	*33730	*33730	*43450	*43450	*39480	25200	*28510	15590	20500	10800			14790	7760	(30.2)
-4.5 m (-15 ft)	kg	*19590	*19590	*24400	*24400	*16540	11640	*12090	7180	*9050	5010			*7560	4660	8.01
	lb	*43190	*43190	*53790	*53790	*36460	25660	*26650	15830	*19950	11050			*16670	10270	(26.3)
-6.0 m (-20 ft)	kg			*19480	*19480	*13530	12160	*9650	7570					*7550	*7550	6.14
	lb			*42950	*42950	*29830	26810	*21270	16690					*16640	*16640	(20.1)

HX380 NL

6,15 m (20' 2") Ausleger; 2,5 m (8' 2") Löffelstiel; 1,62 m³ Löffel (nach SAE gehäuft); 600 mm (24") 3-Steg-Bodenplatten

Lasthöhe m (ft)	Lastradius								Max. Reichweite			
	3.0 m (10 ft)		4.5 m (15 ft)		6.0 m (20 ft)		7.5 m (25 ft)		Volumen	Reichweite		
											m (ft)	
7.5 m (25 ft)	kg									*7140	5360	7.60
	lb									*15740	11820	(24.9)
6.0 m (20 ft)	kg					*8000	*8000	*7650	5460	*7220	4120	8.51
	lb					*17640	*17640	*16870	12040	*15920	9080	(27.9)
4.5 m (15 ft)	kg		*11730	*11730		*9300	7860	*8160	5240	*7410	3480	9.05
	lb		*25860	*25860		*20500	17330	*17990	11550	*16340	7670	(29.7)
3.0 m (10 ft)	kg		*15260	11210	*10940	7190	*8970	4920		7020	3160	9.29
	lb		*33640	24710	*24120	15850	*19780	10850		15480	6970	(30.5)
1.5 m (5 ft)	kg		*17820	10170	*12410	6620	*9770	4610		6940	3080	9.26
	lb		*39290	22420	*27360	14590	*21540	10160		15300	6790	(30.4)
Boden-niveau	kg		*18720	9780	*13290	6270	9760	4400		7290	3220	8.95
	lb		*41270	21560	*29300	13820	21520	9700		16070	7100	(29.4)
-1.5 m (-5 ft)	kg	*20170	20160	*18370	9740	*13390	6160	9690	4340	8230	3690	8.33
	lb	*44470	44450	*40500	21470	*29520	16580	21360	9570	18140	8140	(27.3)
-3.0 m (-10 ft)	kg	*23770	20600	*16880	9950	*12440	6270			*8790	4760	7.31
	lb	*52400	45420	*37210	21940	*27430	13820			*17970	10490	(24.0)
-4.5 m (-15 ft)	kg	*18720	*18720	*13510	10460					*8150	7730	5.64
	lb	*41270	*41270	*29780	23060					*17970	17040	(18.5)
-9.0 m (-30 ft)	kg									*5210	4550	8.69
	lb									*11490	10030	(28.5)















6,5 m (21' 4") Ausleger; 2,5 m (8' 2") Löffelstiel; 1,62 m³ Löffel (nach SAE gehäuft); 600 mm (24") 3-Steg-Bodenplatten

Lasthöhe m (ft)	Lastradius								Max. Reichweite			
	3.0 m (10 ft)		4.5 m (15 ft)		6.0 m (20 ft)		7.5 m (25 ft)		Volumen	Reichweite		
											m (ft)	
9.0 m (30 ft)	kg									*6870	*6870	6.69
	lb									*15150	*15150	(21.9)
7.5 m (25 ft)	kg									*6750	4730	8.04
	lb									*14880	10430	(26.4)
6.0 m (20 ft)	kg					*7870	*7870	*7290	5420	*6820	3680	8.90
	lb					*17350	*17350	*16070	11950	*15040	8110	(29.2)
4.5 m (15 ft)	kg		*12110	*12110		*9260	7660	*7920	5140	6920	3120	9.41
	lb		*26700	*26700		*20410	16890	*17460	11330	15260	6880	(30.9)
3.0 m (10 ft)	kg		*15660	10670	*10910	6950	*8770	4780		6480	2840	9.64
	lb		*34520	23520	*24050	15320	*19330	10540		14290	6260	(31.6)
1.5 m (5 ft)	kg		*17900	9720	*12310	6370	*9570	4460		6410	2760	9.61
	lb		*39460	21430	*27140	14040	*21100	9830		14130	6080	(31.5)
Boden-niveau	kg		*18450	9440	*13100	6040	9590	4240		6700	2880	9.32
	lb		*40680	20810	*28880	13320	21140	9350		14770	6350	(30.6)
-1.5 m (-5 ft)	kg	*17120	*17120	*17970	9450	*13160	5940	9500	4170	7490	3280	8.73
	lb	*37740	*37740	*39620	20830	*29010	13100	20940	9190	16510	7230	(28.6)
-3.0 m (-10 ft)	kg	*22880	20250	*16570	9670	*12350	6040			*8190	4160	7.77
	lb	*50440	44640	*36530	21320	*27230	13320			*18060	9170	(25.5)
-4.5 m (-15 ft)	kg	*18610	*18610	*13720	10140					*7770	6350	6.25
	lb	*41030	*41030	*30250	22350					*17130	14000	(20.5)















 Lastradius Frontauslage  Lastradius Seitenauslage bzw. 360 Grad

HX380 NL

6,5 m (21' 4") Ausleger; 3,2 m (10' 6") Löffelstiel; 1,62 m³ Löffel (nach SAE gehäuft); 600 mm (24") 3-Steg-Bodenplatten

Lasthöhe m (ft)	Lastradius												Max. Reichweite		
	1.5 m (5 ft)		3.0 m (10 ft)		4.5 m (15 ft)		6.0 m (20 ft)		7.5 m (25 ft)		9.0 m (30 ft)		Volumen	Reichweite	
															m (ft)
9.0 m (30 ft)	kg												*5840	5840	7.44
	lb												*12870	12870	(24.4)
7.5 m (25 ft)	kg							*6080	5760				*5870	4150	8.66
	lb							*13400	12700				*12940	9150	(28.4)
6.0 m (20 ft)	kg							*6370	5600				*6010	3280	9.46
	lb							*14040	12350				*13250	7230	(31.0)
4.5 m (15 ft)	kg						*8110	7930	*7090	5270	*6320	3590	*6220	2780	9.94
	lb						*17880	17480	*15630	11620	*13930	7910	*13710	6130	(32.6)
3.0 m (10 ft)	kg			*13710	11270		*9860	7150	*8030	4860	*7050	3380	5900	2510	10.16
	lb			*30230	24850		*21740	15760	*17700	10710	*15540	7450	13010	5530	(33.3)
1.5 m (5 ft)	kg			*16620	9990	*11480	6470	*8970	4470	7220	3170	5810	2420	10.13	
	lb			*36640	22020	*25310	14260	*19780	9850	15920	6990	12810	5340	(33.2)	
Boden-niveau	kg		*11670	*11670	*18010	9380	*12600	6010	9540	4180	7040	3010	6010	2490	9.85
	lb		*25730	*25730	*39710	20680	*27780	13250	21030	9220	15520	6640	13250	5490	(32.3)
-1.5 m (-5 ft)	kg	*13240	*13240	*16670	*16670	*18180	9210	*13040	5800	9360	4030		6610	2780	9.30
	lb	*29190	*29190	*36750	*36750	*40080	20300	*28750	12790	20640	8880		14570	6130	(30.5)
-3.0 m (-10 ft)	kg	*17860	*17860	*22550	19430	*17340	9310	*12710	5790	9370	4040		*7870	3420	8.41
	lb	*39370	*39370	*49710	42840	*38230	20530	*28020	12760	20660	8910		*17350	7540	(27.6)
-4.5 m (-15 ft)	kg			*21770	20110	*15310	9650	*11270	6020				*8060	4890	7.05
	lb			*47990	44330	*33750	21270	*24850	13270				*17770	10780	(23.1)
-6.0 m (-20 ft)	kg					*11030	10360								
	lb					*24320	22840								

6,5 m (21' 4") Ausleger; 3,9 m (12' 10") Löffelstiel; 1,62 m³ Löffel (nach SAE gehäuft); 600 mm (24") 3-Steg-Bodenplatten

Lasthöhe m (ft)	Lastradius												Max. Reichweite			
	1.5 m (5 ft)		3.0 m (10 ft)		4.5 m (15 ft)		6.0 m (20 ft)		7.5 m (25 ft)		9.0 m (30 ft)		Volumen	Reichweite		
															m (ft)	
9.0 m (30 ft)	kg												*5120	4700	8.35	
	lb												*11290	10360	(27.4)	
7.5 m (25 ft)	kg												*5210	3480	9.44	
	lb												*11490	7670	(31.0)	
6.0 m (20 ft)	kg										*4810	3880	*5370	2800	10.17	
	lb										*10600	8550	*11840	6170	(33.4)	
4.5 m (15 ft)	kg							*6290	5450	*5900	3710	*5580	2390	10.62		
	lb							*13870	12020	*13010	8180	*12300	5270	(34.8)		
3.0 m (10 ft)	kg			*20290	*20290	*11890	*11890	*8840	7470	*7320	5020	*6480	3470	5260	2160	10.82
	lb			*44730	*44730	*26210	*26210	*19490	16470	*16140	11070	*14290	7650	11600	4760	(35.5)
1.5 m (5 ft)	kg			*10690	*10690	*15290	10520	*10670	6710	*8390	4590	*7100	3220	5180	2080	10.79
	lb			*23570	*23570	*33710	23190	*23520	14790	*18500	10120	*15650	7100	11420	4590	(35.4)
Boden-niveau	kg			*12110	*12110	*17390	9340	*12080	6150	*9290	4240	7050	3020	5330	2120	10.53
	lb			*26700	*26700	*38340	21250	*26630	13560	*20480	9350	15540	6660	11750	4670	(34.5)
-1.5 m (-5 ft)	kg	*11600	*11600	*15390	*15390	*18190	9270	*12860	5830	9360	4020	6910	2890	5770	2340	10.02
	lb	*25570	*25570	*33930	*33930	*40100	20440	*28350	12850	20640	8860	15230	6370	12720	5160	(32.9)
-3.0 m (-10 ft)	kg	*15300	*15300	*19710	19120	*17910	9220	*12930	5730	9270	3950			6690	2800	9.21
	lb	*33730	*33730	*43450	42150	*39480	20330	*28510	12630	20440	8710			14750	6170	(30.2)
-4.5 m (-15 ft)	kg	*19590	*19590	*24400	19650	*16540	9420	*12090	5830	*9050	4050			*7560	3780	8.01
	lb	*43190	*43190	*53790	43320	*36460	20770	*26650	12850	*19950	8930			*16670	8330	(26.3)
-6.0 m (-20 ft)	kg			*19480	*19480	*13530	9910	*9650	6210					*7550	6380	6.14
	lb			*42950	*42950	*29830	21850	*21270	13690					*16640	14070	(20.1)

- Die Hublast richtet sich nach der Definition in SAE J1097 und ISO 10567.
- Die Hublast der Serie ROBEX darf auf festem, ebenem Untergrund maximal 75 % der Kipplast der Maschine bzw. 87 % der gesamten hydraulischen Hubkraft betragen.

- Der Lasthaken befindet sich an der Rückseite des Tieflöffels.
- (*) gibt die Lastbegrenzung durch die hydraulische Hubkraft an.

MOTOR	STD	OPT
Cummins-Motor QSL 9	●	
HYDRAULIKSYSTEM		
IPC (Intelligent Power Control)		
3 Leistungsstufen, 2 Arbeitsarten, Benutzermodus	●	
Variable Leistungssteuerung	●	
Pumpenfördermengenregelung	●	
Volumenstromregelung für Anbaugerät-Betriebsart		●
Automatischer Motorleerlauf	●	
Automatische Motorabschaltung		●
Elektronische Gebläsesteuerung		●
KABINE UND INNENRAUM		
Kabine nach ISO-Norm		
Ober ruhender Frontscheibenwischer	●	
Radio/USB-Player	●	
Mobiltelefon-Freisprecheinrichtung mit USB	●	
12-Volt-Steckdose (Wandler 24 VDC auf 12 VDC)	●	
Elektrisches Signalhorn	●	
Allwetter-Stahlkabine mit 360°-Rundsicht	●	
Sicherheitsglasscheiben	●	
Frontscheibe einschiebbar	●	
Seitenscheibe (links) als Schiebefenster	●	
Abschließbare Tür	●	
Warmhalte- und Kühlbox	●	
Aufbewahrungsfach und Aschenbecher	●	
Kabinendachabdeckung transparent	●	
Sonnenblende	●	
Tür- und Kabinenschlösser, ein Schlüssel	●	
Mechanisch gefederter, beheizter Sitz	●	
Vorsteuerdruckunterstützter Joystick	●	
Konsole höhenverstellbar	●	
Automatische Klimaregelung		
Klimaanlage und Heizung	●	
Scheibenheizung	●	
Starthilfe (Ansaugluftvorwärmung) bei kalten Temperaturen	●	
Zentrale Überwachung		
8-Zoll-LCD	●	
Motordrehzahl oder Tageszähler/Beschleunigung	●	
Motorkühlmittel-Temperaturanzeige	●	
Max. Leistung	●	
Kriechgang/Schnellgang	●	
Automatischer Leerlauf	●	
Überlast	●	
Motor überprüfen	●	
Luftfilter verstopft	●	
Anzeigen	●	
ÖKO-Anzeigen	●	
Kraftstoffstandanzeige	●	
Anzeige für die Hydrauliköltemperatur	●	
Kraftstoffvorwärmer	●	
Warnungen	●	
Kommunikationsfehler	●	
Batterie niedrig	●	
Uhr	●	
Kabinenscheinwerfer	●	
Regenschutz für Kabinenfrontfenster	●	
Kabinendachabdeckung in Stahl		●
Sitz		
Einstellbarer Fahrersitz mit Luftfederung und Heizung		●
Kabinen-FOPS/FOG (ISO/DIN 10262) Stufe 2		
FOPS (Schutzeinrichtung gegen herabfallende Gegenstände) - ISO 3449 Stufe 2	●	
FOG (Schutzaufbau gegen herabfallende Gegenstände)		●
Kabinen-ROPS (ISO 12117-2)		
ROPS (Überrollschutz)	●	

SICHERHEIT	STD	OPT
Batterie Hauptschalter	●	
Heckkamera	●	
Kameragestützte virtuelle Draufsicht incl. Bewegobjektüberwachung (AAVM + MOD)		●
Vier Arbeitsscheinwerfer	●	
Fahralarm	●	
Arbeitsscheinwerfer hinten	●	
Rundumleuchte		●
Automatische Schwenkbremse	●	
Auslegerhaltesystem	●	
Stielhaltesystem	●	
Sicherheitsventil für Auslegerzylinder mit Überlastwarneinrichtung	●	
Sicherheitsventil für Löffelstielzylinder		●
Drei Außenrückspiegel	●	
SONSTIGES		
Ausleger		
6,15 m; 20' 2"		●
6,5 m; 21' 4"	●	
Löffelstiel		
2,5 m; 8' 2"		●
3,2 m; 10' 6"	●	
3,9 m; 12' 10"		●
Herausnehmbares Kühlerstaubgitter	●	
Herausnehmbarer Vorratsbehälter	●	
Kraftstoffvorfilter	●	
Kraftstoffvorwärmer		●
Selbstdiagnosesystem	●	
Hi-mate (Maschinenmanagementsystem)	●	
Batterien (2 x 12 V x 160 Ah)	●	
Kraftstoffbetankungspumpe (50 l/min)	●	
Einfach wirkende Verrohrung (Hydraulikhammer usw.)		●
Doppelt wirkende Verrohrung (Zweischalengreifer usw.)	●	
Verrohrung für drehende Anbaugeräte		●
Verrohrung für hydraulische Schnellwechsler		●
Schnellwechsler		●
Auslegerschwimmsteuerung		●
Einpedal-Geradeausfahrt		●
Druckspeicher beim Senken der Arbeitseinrichtung	●	
Bedienschema-Umschaltventil (2 Muster)		●
Werkzeugsatz		●
UNTERWAGEN		
Unterbodenschutz Unterwagen (extra)		●
Unterbodenschutz Unterwagen (normal)	●	
Bodenplatten		
3-Steg-Bodenplatten (600 mm; 24")	●	
3-Steg-Bodenplatten (700 mm; 28")		●
3-Steg-Bodenplatten (750 mm; 30")		●
3-Steg-Bodenplatten (800 mm; 32")		●
3-Steg-Bodenplatten (900 mm; 36")		●
2-Steg-Bodenplatten (600 mm; 24")		●
2-Steg-Bodenplatten (700 mm; 28")		●
Bodenplatten für hohe Beanspruchung (600 mm; 24")		●
Bodenplatten für hohe Beanspruchung (700 mm; 28")		●
Laufrollenschutz	●	
Laufrollenschutz "High Walker"		●

STD = Standard
OPT = Optional

- * Standard- und Wahlausstattung können je nach Modell abweichen. Weitere Informationen erhalten Sie von Ihrem Hyundai-Händler. Die Maschinenausstattung kann von internationalen Normen abhängig sein.
- * Auf den Fotos können Anbauten und optionale Geräte abgebildet sein, die in Ihrer Region nicht erhältlich sind.
- * Änderungen der Materialien und technischen Daten vorbehalten.
- * Alle Maße in angloamerikanischen Maßeinheiten sind auf das nächste volle Maß (Pound oder Zoll) gerundet.